



Force Structure and Force Design Updates

Mr. John Stoneburg

LTC Clay Lyle

DAMO FMF



- TAA 18-22**
- Announced Plan**
- 450k TAA Operating Force Bill-Payer Strategy (AC)**
- TAA 19-23**
- Force Design Update Overview**
- ABCT “Triangle” Design**
- Force Design Update Implementation**
- Discussion**



TAA 18-22 is a fully informed capability demand and resourcing informed process:

- Deliver an executable program supporting a 980k force for execution beginning in FY16 and achieving 980k NLT FY17.
- Apply end-strength [reductions below 490k AC, 350.2k ARNG, and 205k USAR](#)
- Apply Resource Management Decision directed changes
- Apply [ARI](#)
- Apply BCT & Headquarter redesign (4 to 3 company in ABCT, enablers, etc)
- Capabilities Demand Analysis (CDA) (Oct 2014 – Dec 2014). Updated scenarios were used and updated based on results of end-strength reductions and any changes to strategy based on Quadrennial Defense Review findings.
- POM 18-22 Force (4 Jul 2015). Intent is to capture SLDA [decisions for FY16-17 actions in ARSTRUC 18-22](#) and receive Senior Leader programming guidance for FY18-22. Due to sensitivity, decisions may not be released until o/a Jul 2015

Army G-3/5/7

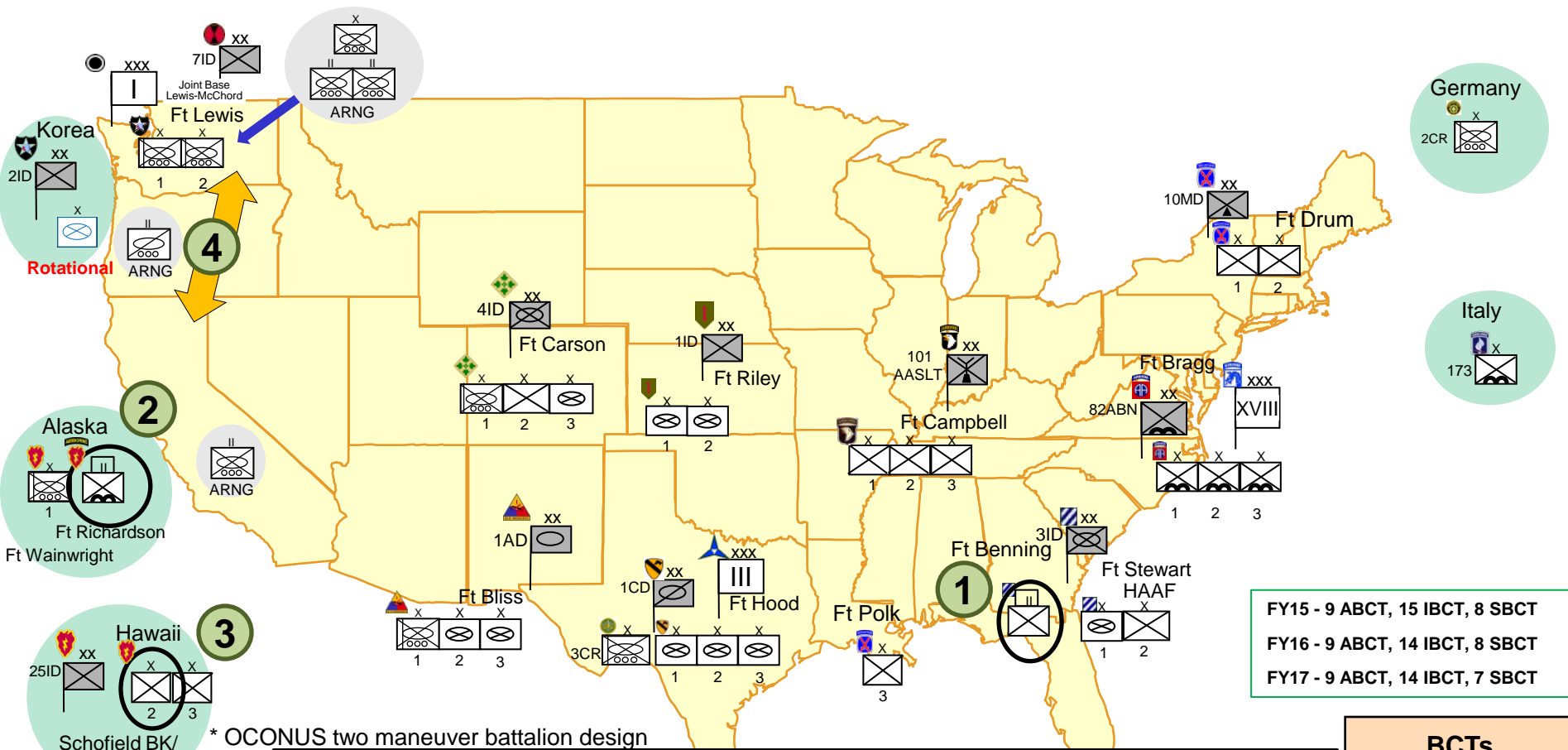





* OCONUS two maneuver battalion design

Changes

- Convert 3/3 ID to Infantry Battalion Task Force (Benning) in FY16
- Convert 4/25 ID to Airborne Battalion Task Force (Richardson) in FY17
- Convert 2/25 SBCT (Hawaii) to IBCT (2-Battalion) in FY17 (Equipment to ARNG)
 - SBCT HQ and two battalions in WA; one battalion in CA; cavalry squadron in OR
 - Three ABCT battalion equipment sets to AC: one each from WA and CA; one from state TBD
- Convert ARNG ABCT to SBCT in FY17

BCTs

	Armored BCT
	Infantry BCT
	Infantry BCT (Airborne)
	Stryker BCT



Army G-3/5/7

Getting to 980k

AC*	
TTHS	- 5.2k
Generating Force	- 4.7k
Enablers	- 4.8k
ARI	- 5.6k
TRADOC Option 4 Redesign FDU's	- 5.8k
FARG	- 3.3k
BCT	- 7.3k
1%	- 4.5k
Total Reductions	- 41.2k
Emerging Growth	+ 1.2k
Total Adjustments to 450k AC	- 40k
ARNG*	
Operating Force Deviation	+1.0k
ARNG Understructure	- 5.7k
ARNG Adjustments	+ 1.5k
ARI	- 3.7k
TRADOC Option 4 Redesign FDU's	- 5.0k
BCT	- 4.4k
ARNG Emerging Growth	+ 1.1k
Total Adjustments to 335k ARNG	- 15.2k
USAR*	
Operating Force Deviation	+1.7k
Generating Force	- 6.0k
USAR Adjustments	- 6.1k
USAR Emerging Growth	+ 0.4k
Total Adjustments to 195k USAR	- 10.0k

* Numbers are approximate due to FDU/TOE approvals

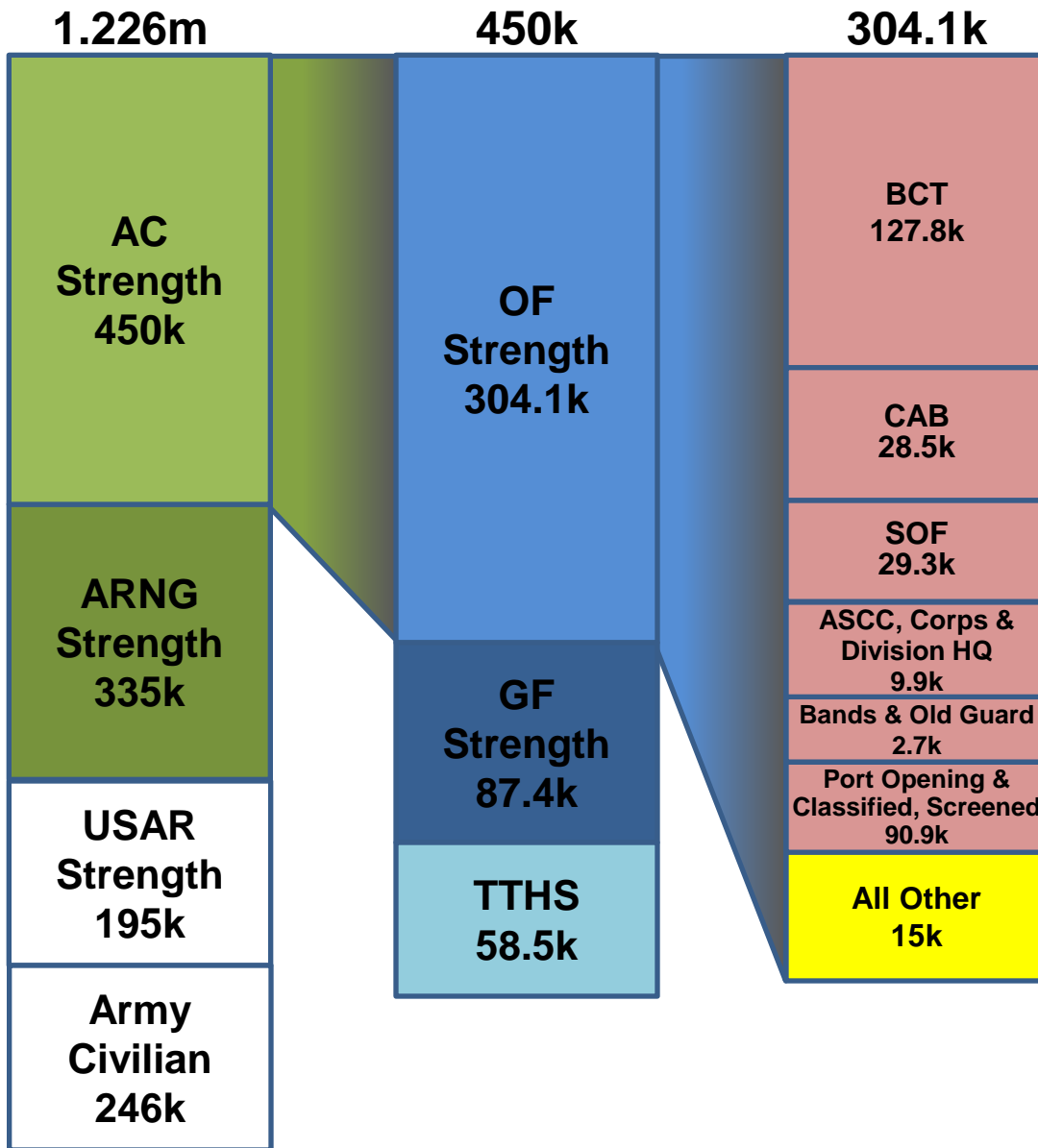



TAA 19-23 will incorporate:

- Force 2025 initiatives (if ready)
- Budget Control Act force structure allowance adjustments below 980k
- Resource Management Decision directed changes
- ARSTRUC Memorandum to capture approved SLDA decisions for all FY18 and beyond actions

Congress will either validate or change the Budget Control Act—this action will impact TAA 19-23



Army G-3/5/7

- ❑ Scout FDU- The SBCT converts from three troops with three 24 man platoons with four Stryker vehicles to three troops with two 36 man platoons with six Stryker vehicles. Combines all the BN MGS and ATGM into a Weapons Company with the MGS in a 4 MGS x 3 PLT configuration.
- ❑ ABCT Battalion Maintenance Officer (BMO) FDU- Address the CSA mandated creation of a Battalion Maintenance Officer (O3) (Maneuver) in the ABCT Combined Arms Battalion (CAB).
- ❑ Unmanned Aerial Surveillance (UAS) Platoon Leader FDU- TUAS platoons outside of Aviation units require additional oversight, leadership, and integration within their support units. This proposed design adds a combat arms branch immaterial PL to the TUAS platoons in Brigade Combat Teams (BCTs), Special Forces Groups (SFGs) and the 75th Ranger Regiment (75th RNGR)
- ❑ CSA COA 4 Reduction- Represents the 16 Dec CSA decision to reduce BCTs and enablers. The reductions include Option 1: elimination of two mechanized infantry companies from the ABCT and supporting enablers; Option 11: consolidation of Company intelligence support teams in the BCTs (included in BCT roll up), standardization of BCT FA Battalion FDC (IBCT, also included in BCT roll up), standardization of CBRN EOD teams to the two man design, Geospatial Planning Team reduction, construction management team reduction, and MP Company removal of PSG driver and gunner; and Option 16 5% reduction in battalion and above headquarters.
- ❑ Division/ Corps 25% Reduction - The Division and Corps FDU explains how a multi-component design will accomplish the Army's requirement to reduce the personnel authorizations for all headquarters at echelons above brigade by 25%, in the aggregate, while retaining an acceptable level of capability and capacity to perform all the roles, missions, functions and tasks of the current Modular Division and Corps headquarters.

ABCT "Triangle" Design

Army G-3/5/7

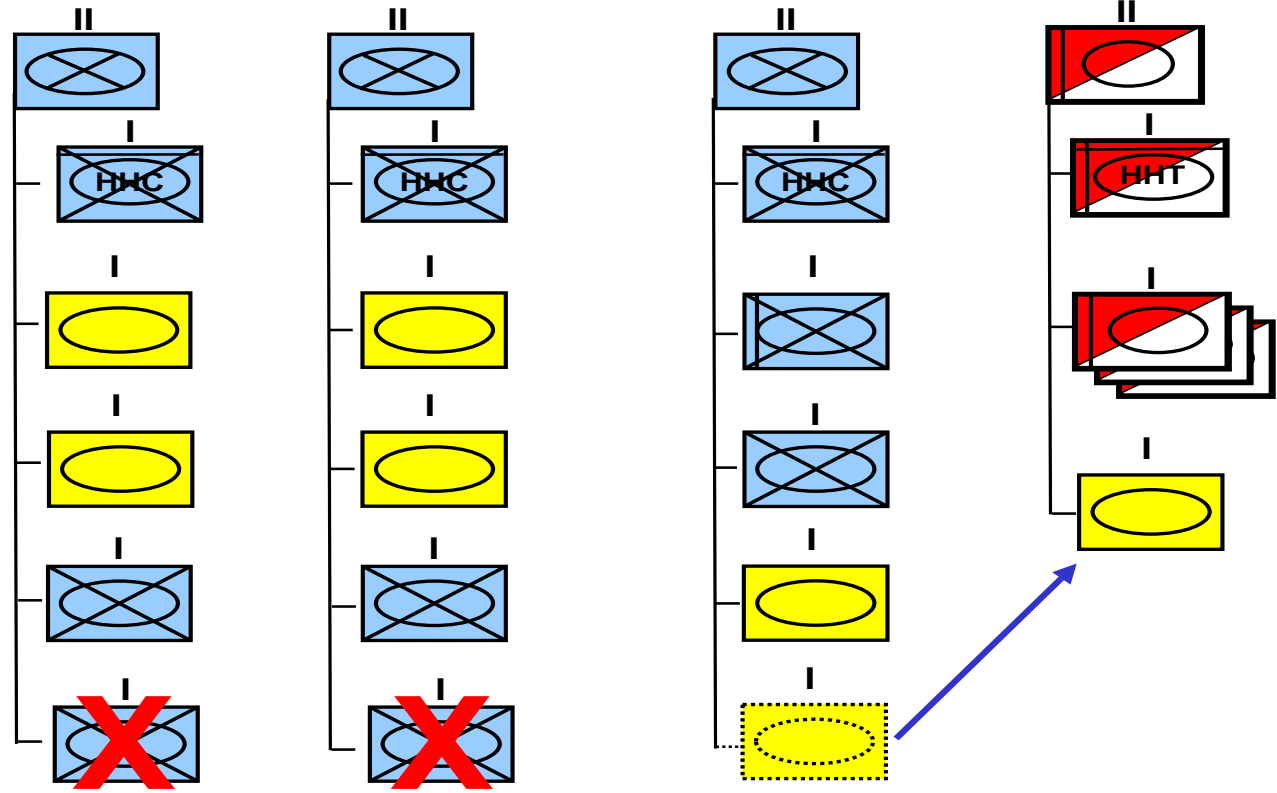

Summary of ABCT changes:

- Bradleys in the CABs reduced by 28 (87 to 59); FA battalion reduced by 2 BFist (15 to 13)
- Total spaces in an ABCT reduced by ~400 (from 4621 to ~4220 pending final FDU approval)
- Two infantry companies removed from two Combined Arms Battalions (CABs)
- One armor company assigned to the Cavalry Squadron
- Medics in CAB HHCs adjusted proportionally; additional medics added to Squadron HHT
- Brigade Support Battalion (BSB) distribution company adjusted
- Forward Support Companies redesigned for armor heavy CAB, infantry heavy CAB, and Cavalry Squadron
- Two infantry company Fire Support Elements (FSE) removed from the Field Artillery Battalion



Army G-3/5/7

UNIT	COMPO	TYPE	AUTS	EDATE	ACTION	AUTS	EDATE	ACTION
FY16								
1/2 ID 3/2 ID	1	SBCT	28 Sep 15	20151018	R EDITION E-MTOE // SBCT SNIPER FDU, HQ REDUX, REFLAGS TO 1/2 ID 20150916	Oct 15	20161116	(K EDITION) SBCT SCOUT FDU
2/2 ID	1	SBCT	28 Sep 15	20151116	R EDITION E-MTOE // SBCT SNIPER FDU, HQ REDUX	Oct 15	20161116	
1/25 ID	1	SBCT	28 Sep 15	20160516	R EDITION E-MTOE // SBCT SNIPER FDU, HQ REDUX	Oct 15	20170516	
2/25 ID	1	SBCT	CONVERTS TO COMPO 1 IBCT AT CURRENT STATION 20161016			Oct 15	20161016	INACTIVATE EFFECTIVE 20161015; CONVERT REMAINDER OF SBCT UICs to 2 MNV BN IBCT (K EDITION) EFFECTIVE 20161016
3CR	1	SBCT	28 Sep 15	20151018	R EDITION E-MTOE // SBCT SNIPER FDU, HQ REDUX	Oct 15	20161016	(K EDITION) SBCT SCOUT FDU
1/1 AD	1	SBCT	28 Sep 15	20160516		Oct 15	20170516	
2CR	1	SBCT	N/A	20151017	DOCUMENT PUBLISHED	N/A	N/A	N/A
1/4 ID	1	SBCT	N/A	20151017		Oct 15	20170516	(K EDITION) SBCT SNIPER FDU, HQ REDUX, SBCT SCOUT FDU, ENVGs
3/1 AD	1	ABCT	28 Sep 15	20151216		Oct 15	20170316	DOCUMENT UPDATE (APPLY 13T NOFC TO FA BN);
2/1 AD	1	ABCT	28 Sep 15	20160116	(K EDITION) TRIANGLE DESIGN, HQ REDUX, BMO FDU	Oct 15	20170116	
3/4 ID	1	ABCT	28 Sep 15	20160216		Oct 15	20170216	DOCUMENT UPDATE
2/1 CD	1	ABCT	28 Sep 15	20160616		Oct 15	20170616	
1/3 ID	1	ABCT	N/A	20151016	DOCUMENT PUBLISHED	NOV 15	20170316	(K EDITION) TRIANGLE DESIGN, HQ REDUX
2/1 ID	1	ABCT	28 Sep 15	20160916	(K EDITION) TRIANGLE DESIGN, HQ REDUX, BMO FDU	Oct 15	20170916	DOCUMENT UPDATE
1/1 CD	1	ABCT	N/A	20151016	DOCUMENT PUBLISHED	Oct 15	20170216	(K EDITION) TRIANGLE DESIGN, HQ REDUX
3/1 CD	1	ABCT	Oct 15	20151216	(K EDITION) TRIANGLE DESIGN, HQ REDUX, BMO FDU	N/A	N/A	
1/1 ID	1	ABCT	Oct 15	20151216		N/A	N/A	
EAS	6	ABCT	Jul 15	20151018	TRIANGLE LIKE DESIGN E-MTOE	Oct 15	20161016	(K EDITION) EQUIPMENT ONLY TRIANGLE DESIGN
KEES	1	ABCT	N/A	N/A	N/A	Oct 15	20161016	
173rd	1	IBCT	28 Sep 15	20160916	(K EDITION) HQ, REDUX	NOV 15	20170916	DOCUMENT UPDATE
1/82 ID	1	IBCT	N/A	20151016	DOCUMENT PUBLISHED	NOV 15	20161216	(K EDITION) HQ, REDUX
2/82 ID	1	IBCT	28 Sep 15	20160316	(K EDITION) HQ, REDUX	NOV 15	20170316	
3/82 ID	1	IBCT	28 Sep 15	20160116		NOV 15	20170116	DOCUMENT UPDATE (APPLY 13T NOFC TO FA BN)
2/25 ID	1	IBCT				NOV 15	20161016	CONVERT REMAINDER OF SBCT UICs to 2 MNV BN IBCT (K EDITION) EFFECTIVE 20161016
3/25 ID	1	IBCT	28 Sep 15	20160916		NOV 15	20170916	DOCUMENT UPDATE (APPLY 13T NOFC TO FA BN)
4/25 ID	1	IBCT	28 Sep 15	20151017		15-Nov	20161015	CONVERTS TO ABN BN TF (K EDITION) EFFECTIVE 20161016; REMAINING UICs OF 4-25 INACTIVATE 20161015
1/10 MTN	1	IBCT	28 Sep 15	20160916	(K EDITION) HQ, REDUX	NOV 15	20170916	
2/10 MTN	1	IBCT	28 Sep 15	20160616		NOV 15	20170616	
3/10 MTN	1	IBCT	28 Sep 15	20160916		NOV 15	20170916	DOCUMENT UPDATE (APPLY 13T NOFC TO FA BN)
1/101 ID	1	IBCT	28 Sep 15	20151017		NOV 15	20161016	
2/101 ID	1	IBCT	N/A	20151016	DOCUMENT PUBLISHED	NOV 15	20170516	(K EDITION) HQ, REDUX
3/101 ID	1	IBCT	28 Sep 15	20160116	(K EDITION) HQ, REDUX	NOV 15	20170116	DOCUMENT UPDATE (APPLY 13T NOFC TO FA BN)
2/4 ID 4/4	1	IBCT	N/A	20151016	DOCUMENT PUBLISHED	NOV 15	20170216	
2/3 ID	1	IBCT	N/A	20151016		NOV 15	20170216	(K EDITION) HQ, REDUX
3/3 ID	1	IBCT	Oct 15	20151216	CONVERTS TO BN TF (K EDITION) EFFECTIVE 20151216;	N/A	N/A	N/A
1-28 IN TF	1	IN BN TF	Oct 15	20151216	REFLAGS FROM 1-15 IN TO 1-28 IN AND CONVERTS TO BN TF EFFECTIVE 20151216	N/A	N/A	N/A
3-509 ABN BN TF	1	ABN BN TF	N/A	N/A	N/A	15-Nov	20161015	CONVERT TO ABN BN TF (K EDITION) EFFECTIVE 20161016

Notes:

- All SBCTs in FY16 will be on R-Edition EMTOEs and will convert to K-Edition TOEs in FY17 when SBCT Scout FDU is applied
- 2/25 – Converts from SBCT to IBCT at home station; FY17 document will reflect IBCT 2MN BN Format K-Edition TOE
- 2/CR – FY18 document has SBCT Sniper FDU, HQ Redux FDU, SBCT Scout FDU, and ENVGs applied to their K-Edition TOE
- 3/3 – Converts to BN TF design in FY16
- 4/25 – Converts to BN TF design in FY17



Discussion